

CLEAN DESIGN

COMPATIBLE FIXTURES
FOR GEBERIT INSTALLATION SYSTEMS

DESIGN
MEETS
FUNCTION



THE POSSIBILITIES

WALL-HUNG TOILET MODELS

Axent

www.axentbath.us

AxentOne Plus
Italica

Blu

Bathworks

www.blubathworks.com

Coco
Metrix

Bocchi

www.bocchiusa.com

Milano
Firenze
Vettore

Catalano

www.catalano.it

Sfera 54
Zero

Crosswater

www.crosswaterlondon.com

MPRO
Ressa X2

Devon & Devon

www.devon-devon.com

Blues
Etoile
New Etoile
Rose
Classica
Westminster

Duravit

www.duravit.com

Darling New
D-Code
D-Neo
DuraStyle
Duravit No. 1
Happy D.2
Starck 2
Starck 3
Starck 3 compact
Vero Air
ME by Starck
Gatego
White Tulip

DXV

www.dxv.com

Belshire
Cossu
Modulus

Icera

www.icerausa.com

Karo
Vista

Kallista

www.kallista.com

Pleó

Kohler

www.us.kohler.com

Memoirs
Veil

Lacava

www.lacava.com

Giulia
Navi
Suave

Laufen

www.us.laufen.com

IIBagnoAlessi One
Kartell
Laufen Pro
The New Classic
Val

Neo-Metro

www.neo-metro.com

Euro-Urban
Metaal
miniLOO

Signature Hardware

www.signaturehardware.com

Arnelle

TOTO

www.totousa.com

AP/AP+
EP/EP+
RP/RP+
RP compact
SP/SP+
Neorest

Villeroy & Boch

www.villeroy-boch.com

Memento
Subway

...ARE GROWING

UNLOCK YOUR IMAGINATION LIKE NEVER BEFORE

FREEDOM TO CREATE **CHOOSE ANY BOWL**

When you install the Geberit system, you're not just getting the best in-wall tank and carrier available. You get the design freedom that only Geberit offers: compatibility with all wall-hung toilets made by every major ceramic manufacturer. Beware of "proprietary" claims and dedicated bowl/carrier combinations. No other carrier gives you the flexibility of the Geberit system.

If you're looking for more ideas and inspiration, use your smartphone to scan the QR code or point your web browser to [geberitnorthamerica.com/inspiration](https://www.geberitnorthamerica.com/inspiration).



↑
Geberit 2x6 in-wall system with Duravit Happy D.2 toilet

WHY BUY GEBERIT

For over 125 years, Geberit has focused on innovation, quality, and reliability. More than 50 years ago, Geberit introduced the first in-wall system. Ever since, the Geberit system has enabled designers and homeowners to create unique spaces by lifting the toilet off the floor.

GEBERIT SYSTEMS:

- achieve a clean, modern look
- have a greater flexibility of toilet placement in a bathroom
- open up space in the bathroom for easier cleaning and greater accessibility

When you buy Geberit, you buy from the company that invented the in-wall toilet system.

Go ahead and choose the perfect toilet for your new bathroom. Then, make sure Geberit is behind the wall.



↑
Geberit 2x6 in-wall system with Sigma70 flush plate and Duravit toilet

COMPATIBLE WALL-HUNG WASHDOWN TOILETS

1.28/0.8 GPF (4.8/3 LPF)

Geberit Installation Systems and wall-hung toilet combinations marked with this symbol (■) in the table are compatible. Please note that all dimensions are approximations.

All toilet dimensions are shown as follows:

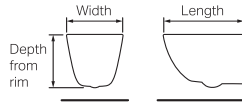

Brand Name	Model Number*	Model Name	111.902 Toilet Carrier 2x6 Stud Wall	111.597 Toilet Carrier 2x4 Stud Wall	111.018 Toilet Carrier Pre-Wall	Length	Width	Depth	Style
Axent	E310	AxentOne Plus	■	■	■	23-1/3	14-1/2	15-2/3	Elongated
	W718	Italica	■	■	■	21-4/5	14	15-1/2	Elongated
Bocchi	1632	Milano	■	■	■	21	14-5/8	14-1/4	Elongated
	1304	Firenze	■	■	■	21	13-3/8	12-1/2	Elongated
	1416	Vettore	■	■	■	21-1/2	14-1/4	13	Elongated
Catalano	VSF54R	Sfera 54	■	■	■	21-1/4	13-3/4	15	Round front
	VS55NR	Zero Newflush	■	■	■	21-5/8	13-3/4	12	Round front
Duravit	257709	D-Neo	■	■	■	21-1/4	14-5/8	14-1/8	Elongated
	251009	ME by Starck	■	■	■	18-7/8	14-1/8	15-3/4	Elongated
	252909	ME by Starck	■***	■***	■**	17-3/8	14-1/8	15-3/4	Round Front
	252959	ME by Starck	■	■	■	21-1/4	14-5/8	15-3/4	Elongated
	253009	ME by Starck	■	■	■**	18-7/8	14-5/8	13-3/4	Round Front
	257909	ME by Starck	■	■	■	22-1/2	14-5/8	14-1/8	Round Front
	255609	Qatego	■	■	■	18-1/8	15-3/8	11-1/4	Elongated
	257609	White Tulip	■	■	■	21-1/4	14-5/8	14-3/8	Round Front
Laufen	8.2033.9	Kartell	■	■	■	21-1/2	14-9/16	15	Round Front
	8.2085.8	The New Classic	■	■	■	20-7/8	14-5/8	13-3/4	Round Front
	8.2028.8	Val	■	■	■	20-7/8	15-3/8	13-1/2	Round Front
TOTO****	CT426CFG#01	AP	■	■	■	21-1/4	15	13-1/4	Elongated
	CT426CFG40#01	AP+	■	■	■	21-1/4	15	13-1/4	Elongated
	CT428CFG#01	EP	■**	■**	■**	21-1/4	15	13-1/4	Elongated
	CT428CFG40#01	EP+	■**	■**	■**	21-1/4	15	13-1/4	Elongated
	CT447CFG#01	RP	■	■	■	22-7/8	15	13-1/8	Elongated
	CT427CFG#01	RP Compact	■	■	■	19-1/4	15	12-3/4	Compact
	CT447CFG60#01	RP+	■	■	■	22-7/8	15	13-1/8	Elongated
	CT449CFG#01	SP	■	■	■	22-7/8	15	13-1/4	Rectangular
	CT449CFG60#01	SP+	■	■	■	22-7/8	15	13-1/4	Rectangular
	CT996CEFX#01	Neorest AC	■	■	■	26-9/16	16-1/4	18-1/8	Square
	CT994CEFG#01	Neorest EW	■	■	■	26-9/16	16-1/4	18-1/8	Square
	CT9538CEFG#01	Neorest WX1	■	■	■	26-5/8	17-5/8	17-1/2	Elongated
CT9548CEFX#01	Neorest WX2	■	■	■	26-5/8	17-5/8	17-1/2	Elongated	

COMPATIBLE WALL-HUNG WASHDOWN TOILETS

1.28/0.8 GPF (4.8/3 LPF) WaterSense Listed

Geberit Installation Systems and wall-hung toilet combinations marked with this symbol (■) in the table are compatible. Please note that all dimensions are approximations.

All toilet dimensions are shown as follows:

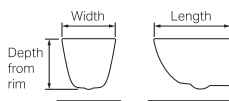

Brand Name	Model Number*	Model Name	111.902 Toilet Carrier 2x6 Stud Wall	111.597 Toilet Carrier 2x4 Stud Wall	111.018 Toilet Carrier Pre-Wall	Length	Width	Depth	Style
Axent	E310	AxentOne Plus	■	■	■	23-1/3	14-1/2	15-2/3	Elongated
	W718	Italica	■	■	■	21-4/5	14	15-1/2	Elongated
Bocchi	1632	Milano	■	■	■	21	14-5/8	14-1/4	Elongated
	1304	Firenze	■	■	■	21	13-3/8	12-1/2	Elongated
Catalano	VSF54R	Sfera 54	■	■	■	21-1/4	13-3/4	15	Round front
	VS55NR	Zero Newflush	■	■	■	21-5/8	13-3/4	12	Round front
Duravit	257709	D-Neo	■	■	■	21-1/4	14-5/8	14-1/8	Elongated
	251009	ME by Starck	■	■	■	18-7/8	14-1/8	15-3/4	Elongated
	252909	ME by Starck	■***	■	■	17-3/8	14-1/8	15-3/4	Round Front
	252959	ME by Starck	■	■	■	21-1/4	14-5/8	15-3/4	Elongated
	253009	ME by Starck	■	■	■**	18-7/8	14-5/8	13-3/4	Round Front
	257909	ME by Starck	■	■	■	22-1/2	14-5/8	14-1/8	Round Front
	255609	Qatego	■	■	■	18-1/8	15-3/8	11-1/4	Elongated
	257609	White Tulip	■	■	■	21-1/4	14-5/8	14-3/8	Round Front
Laufen	8.2033.9	Kartell	■	■	■	21-1/2	14-9/16	15	Round Front
	8.2085.8	The New Classic	■	■	■	20-7/8	14-5/8	13-3/4	Round Front
	8.2028.8	Val	■	■	■	20-7/8	15-3/8	13-1/2	Round Front
TOTO****	CT426CFG#01	AP	■	■	■	21-1/4	15	13-1/4	Elongated
	CT426CFG40#01	AP+	■	■	■	21-1/4	15	13-1/4	Elongated
	CT428CFG#01	EP	■**	■**	■**	21-1/4	15	13-1/4	Elongated
	CT428CFG40#01	EP+	■**	■**	■**	21-1/4	15	13-1/4	Elongated
	CT447CFG#01	RP	■	■	■	22-7/8	15	13-1/8	Elongated
	CT427CFG#01	RP Compact	■	■	■	19-1/4	15	12-3/4	Compact
	CT447CFG60#01	RP+	■	■	■	22-7/8	15	13-1/8	Elongated
	CT449CFG#01	SP	■	■	■	22-7/8	15	13-1/4	Rectangular
	CT449CFG60#01	SP+	■	■	■	22-7/8	15	13-1/4	Rectangular

* Consult toilet manufacturers for up-to-date model numbers and availability.

** Meets 600 grams MaP performance score.

*** Meets 800 grams MaP performance score.

**** TOTO autoflush function not compatible (disabled). Hands-free activation is available using Geberit Type 10 IR button. Contact Geberit for more information.

COMPATIBLE WALL-HUNG WASHDOWN TOILETS

1.6/0.8 GPF (6/3 LPF)

Geberit Installation Systems and wall-hung toilet combinations marked with this symbol (■) in the table are compatible. Please note that all dimensions are approximations

All toilet dimensions are shown as follows:

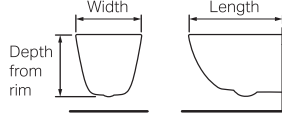

Brand Name	Model Number*	Model Name	111.335 Toilet Carrier 2x6 Stud Wall	111.798 Toilet Carrier 2x4 Stud Wall	111.012 Toilet Carrier Pre-Wall	Length	Width	Depth	Style
Blu Bathworks	LW6008	Coco	■	■	■	22	14	14-1/4	Elongated
	LW6030A	Coco	■	■	■	21-1/4	14-1/4	12-1/4	Elongated
	LW6020A	Metrix	■	■	■	21-1/2	14-1/4	13	Elongated
Crosswater	US-PRO1050	MPRO	■	■	■	23-1/2	14	16-3/4	Elongated
	US-RS200	RESSA X2	■	■	■	23-7/8	15-5/8	17-1/8	Elongated
Devon & Devon	IBWWCSBLU	Blues	■	■	■	21-7/8	14	14-3/8	Round Front
	IBWWCSNET	Etoile	■	■	■	21-1/2	15-3/16	14	Round Front
	IBWWCSET	New Etoile	■	■	■	21-1/2	15-3/16	14	Round Front
	IBWWCSRO	Rose	■	■	■	21-5/8	14	14-3/4	Round Front
Duravit	253509	D-Code	■***	■	■	21-1/2	14	13-3/8	Round Front
	254409	Darling New	■**	■	■	24-5/8	14-3/8	13-5/8	Elongated
	254459	Darling New	■**	■	■	24-5/8	14-3/8	13-5/8	Elongated
	254509	Darling New	■	■	■	21-1/4	14-3/8	13-5/8	Round Front
	253709	DuraStyle	■**	■	■**	24-3/8	14-5/8	13-5/8	Elongated
	253759	DuraStyle	■**	■	■**	24-3/8	14-3/4	13-5/8	Elongated
	253809	DuraStyle	■	■	■	21-1/4	14-5/8	13-3/4	Rectangular
	254209	DuraStyle	■***	■	■	24-3/8	14-5/8	13-3/4	Elongated
	255109	DuraStyle	■	■	■	21-1/4	14-5/8	14	Rectangular
	256209	Duravit No. 1	■***	■	■	21-1/4	14-3/8	13-3/4	Round Front
	222209	Happy D.2	■	■	■	21-1/4	14-3/8	13-1/8	Rectangular
	255009	Happy D.2	■	■	■	24-3/8	14-3/8	13-5/8	Elongated
	253309	Starck 2	■	■	■	24-3/8	14-3/4	13-1/4	Elongated
	253409	Starck 2	■	■	■	21-1/4	14-5/8	13	Round Front
	222509	Starck 3	■***	■	■	21-1/4	14-1/8	12	Round Front
	222609	Starck 3	■	■	■	24-3/8	14-5/8	13-5/8	Elongated
	222659	Starck 3	■	■	■	24-3/8	14-5/8	13-5/8	Elongated
252709	Starck 3	■***	■	■	21-1/4	14-1/8	13-3/8	Round Front	
222709	Starck 3 compact	■	■	■	19-1/8	14-1/8	13-3/8	Round Front	
252509	Vero Air	■***	■	■	22-1/2	14-5/8	14	Rectangular	
DXV	D23050A000	Belshire	■	■	■	18-3/8	13-7/8	13-3/4	Round Front
	D23010S000	Cossu	■	■	■	17-1/2	14-1/2	13-3/4	Round Front
	D23040A000	Modulus	■	■	■	18-1/2	14-3/16	13-3/4	Rectangular
Icera	C-5170	Karo	■	■	■	18-1/8	14-1/8	14-1/8	Elongated
	C-5530	Vista	■	■	■	17-3/4	14	14-3/8	Elongated
Kallista	P70361-00-0	Pleó	■	■	■	21	14-1/4	13	Elongated
Kohler	K-6918	Memoirs	■	■	■	24-3/8	17	14-11/16	Square
	K-31539	Veil	■	■	■	21	15-1/8	13-3/4	Elongated
	K-76395	Veil Intelligent	■	■	■	21	15-1/8	13-3/4	Elongated
Lacava	5051WC	Giulia	■	■	■	22	14	14	Round Front
	5051WC-MB	Navi	■	■	■	19-3/4	14	13	Round Front
	6058.1	Suave	■	■	■	22	15-1/2	14-1/4	Round Front
Laufen	820978	IlBagnoAlessi One	■	■**	■	23	15-3/8	14	Elongated
	820950	Laufen Pro	■***	■	■	22-1/16	14-3/16	15-3/4	Round Front
	820968	Laufen Pro	■	■	■	20-7/8	14-3/16	13-5/8	Round Front
Neo-Metro	8951-W-1	Euro-Urban	■	■	■	23	13-3/4	14	Elongated
	8957	Metaal	■	■	■	29-1/4	15	14	Elongated
	8952	miniLOO	■	■	■	20-1/2	13-3/4	14-1/8	Round Front
Signature Hardware	SH111003B	Arnelle	■	■	■	21-1/4	14-3/8	12-1/4	Elongated
Villeroy & Boch	5628 U1 XX	Memento	■	■	■	22	14-3/4	16-1/8	Rectangular
	4609 UR XX	Subway	■**	■	■	22-7/8	16-1/8	13-1/8	Round Front
	5600 U0 XX	Subway	■	■	■	22-1/4	14-3/4	14-1/8	Round Front
	5614 UR XX	Subway	■	■	■	22	14-5/8	14-3/8	Round Front

* Consult toilet manufacturers for up-to-date model numbers and availability.

** Meets 600 grams MaP performance score.

*** Meets 800 grams MaP performance score.

The information contained in this document is subject to change without notice.

COMPATIBLE WALL-HUNG WASHDOWN TOILETS

1.6/0.8 GPF (6/3 LPF) WaterSense Listed

Geberit Installation Systems and wall-hung toilet combinations marked with this symbol (■) in the table are compatible. Please note that all dimensions are approximations.

All toilet dimensions are shown as follows:

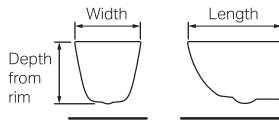

Brand Name	Model Number*	Model Name	Toilet Carrier			Length	Width	Depth	Style
			111.335 2x6 Stud Wall	111.798 2x4 Stud Wall	111.012 Pre-Wall				
						(Toilet dimensions in inches)			
Crosswater	US-PRO1050	MPRO	■	■	■	23-1/2	14	16-3/4	Elongated
Duravit	253509	D-Code	■			21-1/2	14	13-3/8	Round Front
	254409	Darling New	■**			24-5/8	14-3/8	13-5/8	Elongated
	254459	Darling New	■**			24-5/8	14-3/8	13-5/8	Elongated
	254509	Darling New	■***			21-1/4	14-3/8	13-5/8	Round Front
	253709	DuraStyle	■**			24-3/8	14-5/8	13-5/8	Elongated
	253809	DuraStyle	■			21-1/4	14-5/8	13-3/4	Rectangular
	254209	DuraStyle	■***			24-3/8	14-5/8	13-3/4	Elongated
	255109	DuraStyle	■			21-1/4	14-5/8	14	Rectangular
	256209	Duravit No. 1	■***			21-1/4	14-3/8	13-3/4	Round Front
	222209	Happy D.2	■			21-1/4	14-3/8	13-1/8	Rectangular
	255009	Happy D.2	■			24-3/8	14-3/8	13-5/8	Elongated
	253309	Starck 2	■			24-3/8	14-3/4	13-1/4	Elongated
	253409	Starck 2	■			21-1/4	14-5/8	13	Round Front
	222509	Starck 3	■***	■		21-1/4	14-1/8	12	Round Front
	222609	Starck 3	■	■		24-3/8	14-5/8	13-5/8	Elongated
	222659	Starck 3	■			24-3/8	14-5/8	13-5/8	Elongated
	252709	Starck 3	■***			21-1/4	14-1/8	13-3/8	Round Front
	222709	Starck 3 compact	■			19-1/8	14-1/8	13-3/8	Round Front
DXV	D23050A000	Belshire	■	■	■	18-3/8	13-7/8	13-3/4	Round Front
	D23010S000	Cossu	■	■	■	17-1/2	14-1/2	13-3/4	Round Front
	D23040A000	Modulus	■	■	■	18-1/2	14-3/16	13-3/4	Rectangular
Icera	C-5170	Karo	■			18-1/8	14-1/8	14-1/8	Elongated
	C-5530	Vista	■			17-3/4	14	14-3/8	Elongated
Kohler	K-6918	Memoirs	■	■	■	24-3/8	17	14-1/16	Square
	K-31539	Veil	■	■	■	21	15-1/8	13-3/4	Elongated
	K-76395	Veil Intelligent	■	■	■	21	15-1/8	13-3/4	Elongated
Lacava	5051WC	Giulia	■			22	14	14	Round Front
	6058.1	Suave	■			22	15-1/2	14-1/4	Round Front
Laufen	820978	IlBagnoAlessi One	■	■**	■	23	15-3/8	14	Elongated
	820950	Laufen Pro	■***	■		22-1/16	14-3/16	15-3/4	Round Front
	820968	Laufen Pro	■	■		20-7/8	14-3/16	13-5/8	Round Front
Signature Hardware	SH111003B	Arnelle	■	■	■	21-1/4	14-3/8	12-1/4	Elongated
Villeroy & Boch	5628 U1 XX	Memento	■			22	14-3/4	16-1/8	Rectangular
	4609 UR XX	Subway	■**			22-7/8	16-1/8	13-1/8	Round Front
	5600 U0 XX	Subway	■			22-1/4	14-3/4	14-1/8	Round Front
	5614 UR XX	Subway	■			22	14-5/8	14-3/8	Round Front

* Consult toilet manufacturers for up-to-date model numbers and availability.

** Meets 600 grams MaP performance score.

*** Meets 800 grams MaP performance score.

The information contained in this document is subject to change without notice.

HOW CAN I TELL IF A WALL-HUNG TOILET IS COMPATIBLE?

With Geberit in-wall systems 111.335, 111.902, 111.798, 111.597, 111.012 or 111.018

1 Check water consumption.

Washdown style bowls must flush with 1.28 GPF (4.8 LPF) or 1.6 GPF (6 LPF) single flush 1.28/0.8 GPF (4.8/3 LPF) or 1.6/0.8 GPF (6/3 LPF) dual-flush. If you do not know your water consumption go to Step 5.

KNOW YOUR WATER CONSUMPTION? GO TO STEP 2.

2 How many mounting holes?

Wall-hung bowls come with several mounting hole styles – 4 hole, 3 hole and 2 hole.

Bowls compatible with Geberit systems have 2 mounting holes.

HAVE 2 MOUNTING HOLES? GO TO STEP 3.

Syphonic bowl (four holes)

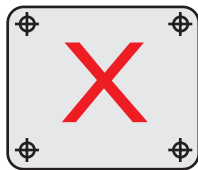

Blowout bowl (three holes)

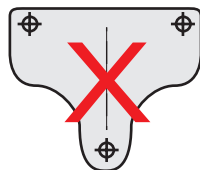

Washdown bowl (two holes)

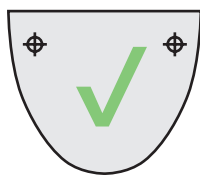

3 Where does water go into bowl?

Typically from above (exposed) or from behind (hidden) for wall-hung bowls.

Bowls compatible with Geberit systems have a hidden water supply from behind.

HAVE CONCEALED WATER SUPPLY FROM BEHIND? GO TO STEP 4.

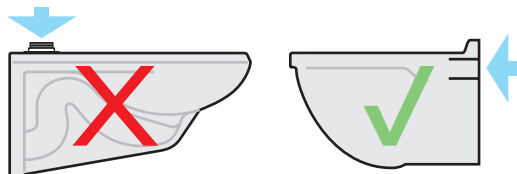

4 Check dimensions.

If you get to this point, the final step is to check the following dimensions:

- Mounting dimensions
- Water supply inlet dimensions
- Waste outlet dimensions

IF YOU END HERE WITHOUT A MATCH, GO TO STEP 5.

a) Mounting dimensions

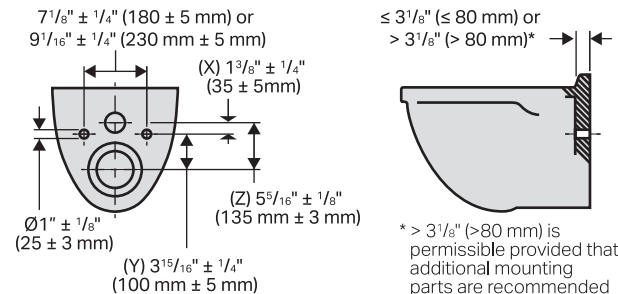

Note: The sum of (X) and (Y) tolerances should not exceed the specified limits of (Z).

* > 3 1/8" (>80 mm) is permissible provided that additional mounting parts are recommended or supplied by the manufacturer.

b) Water supply inlet dimensions

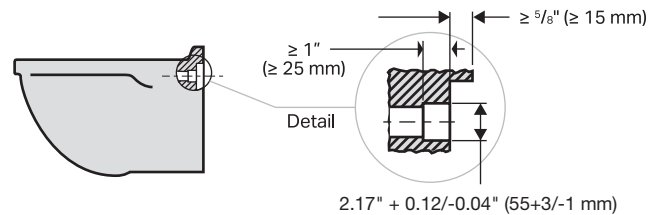

c) Waste outlet dimensions

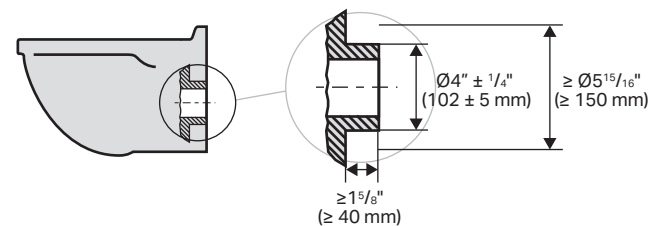

5 Contact us.

800/TEC-TRUE
techsupport.us@geberit.com

COMPATIBLE FLOOR-MOUNT WASHDOWN TOILETS

Geberit Installation Systems and wall-hung toilet combinations marked with this symbol (■) in the table are compatible. Please note that all dimensions are approximations.

1.28/0.8 GPF (4.8/3 LPF)

All toilet dimensions are shown as follows:

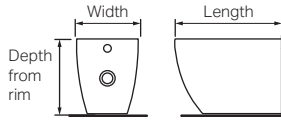

Brand Name	Model Number*	Model Name	109.307	109.781	Length (Toilet dimensions in inches)	Width (Toilet dimensions in inches)	Depth (Toilet dimensions in inches)	Style
Duravit	216909	ME by Starck	■	■	17-3/8	14-1/8	15-3/4	Round Front
	216959	ME by Starck	■	■	21-1/4	14-5/8	15-3/4	Elongated
Catalano	VPS54R	Sfera 54 Newflush	■	■	21-1/4	13-3/4	16-1/4	Round Front
Laufen	823339	Kartel	■	■	22-1/8	14-5/8	16-15/16	Round Front

1.28/0.8 GPF (4.8/3 LPF) WaterSense Listed

All toilet dimensions are shown as follows:

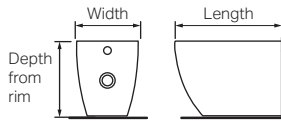

Brand Name	Model Number*	Model Name	109.307	109.781	Length (Toilet dimensions in inches)	Width (Toilet dimensions in inches)	Depth (Toilet dimensions in inches)	Style
Duravit	216909	ME by Starck	■	■	17-3/8	14-1/8	15-3/4	Round Front
	216959	ME by Starck	■	■	21-1/4	14-5/8	15-3/4	Elongated
Catalano	VPS54R	Sfera 54 Newflush	■	■	21-1/4	13-3/4	16-1/4	Round Front

1.6/0.8 GPF (6/3 LPF)

All toilet dimensions are shown as follows:

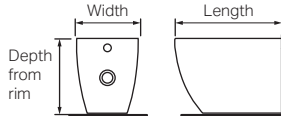

Brand Name	Model Number*	Model Name	109.304	Length (Toilet dimensions in inches)	Width (Toilet dimensions in inches)	Depth (Toilet dimensions in inches)	Style
Devon & Devon	WCBTWBLU	Blues	■	20-3/8	14	15-3/4	Round Front
	WCBTWCLA	Classica	■	20-5/8	14-1/4	15-1/2	Round Front
	WCBTWET	Etoile	■	19-1/4	15-3/8	15-3/4	Round Front
	WCBTWNET	New Etoile	■	20-1/4	14	15-3/4	Round Front
	WCBTWROS	Rose	■	20-1/4	14-3/16	15-3/16	Round Front
	WCBTWWES	Westminster	■	21-1/2	14-3/8	15-1/2	Round Front
	Neo-Metro	8951-W-2	Euro-Urban	■	23	13-3/4	14
Villeroy & Boch	6607 U1 XX	Subway	■	22-1/2	14-5/8	15-3/4	Round Front

* Consult toilet manufacturers for up-to-date model numbers and availability.

** Meets 600 grams MaP performance score.

The information contained in this document is subject to change without notice.

HOW CAN I TELL IF A FLOOR-MOUNT TOILET IS COMPATIBLE? With Geberit in-wall flushing system 109.304, 109.307 or 109.797

1 Check water consumption.

Washdown style bowls must flush with 1.6 GPF (6 LPF) single flush or 1.6/0.8 GPF (6/3 LPF) dual-flush. If you do not know your water consumption, go to Step 5.

KNOW YOUR WATER CONSUMPTION? GO TO STEP 2.

2 Where does water go into bowl?

Typically from above (exposed) or from behind (hidden). Bowls compatible with Geberit systems have a hidden water supply from behind.

HAVE CONCEALED WATER SUPPLY FROM BEHIND AND WITHOUT FLUSHOMETER SPUD? GO TO STEP 3.

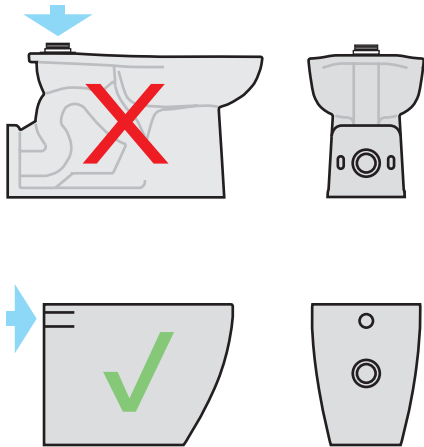

3 Check dimensions.

- a) Connection orientation
- b) Water supply inlet dimensions
- c) Waste outlet dimensions

IF YOU END HERE WITHOUT A MATCH, GO TO STEP 5.

a) Mounting dimensions

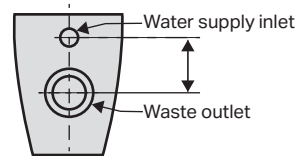

b) Water supply inlet dimensions

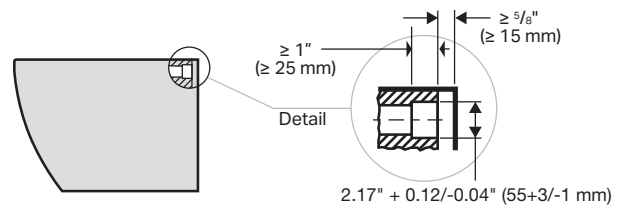

c) Waste outlet dimensions

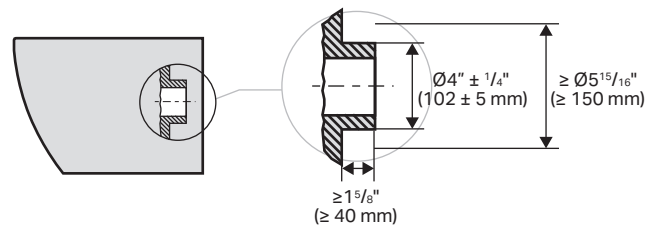

4 Contact us.

800/TEC-TRUE
techsupport.us@geberit.com

COMPATIBLE WALL-HUNG URINALS

Geberit Installation Systems and wall-hung toilet combinations marked with this symbol (■) in the table are compatible. Please note that all dimensions are approximations.

0.5 GPF (1.9 LPF)*

All toilet dimensions are shown as follows:

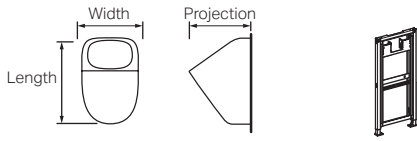

Brand Name	Model Number**	Model Name	111.625 Urinal Carrier	Projection (Urinal dimensions in inches)	Length (Urinal dimensions in inches)	Width (Urinal dimensions in inches)
Duravit	280930	ME by Starck	■	13-3/4	23	11-3/4

0.125 GPF (0.5 LPF)*

All toilet dimensions are shown as follows:

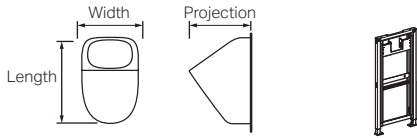

Brand Name	Model Number**	Model Name	111.625 Urinal Carrier	Projection (Urinal dimensions in inches)	Length (Urinal dimensions in inches)	Width (Urinal dimensions in inches)
Laufen	840975	Il Bagno Alessi One	■	11-3/8	23	12-3/4

* Combination meets EPA WaterSense when combined with Geberit urinal carrier and with EPA WaterSense certified Geberit urinal flushometer controls.

** Consult urinal manufacturers for up-to-date model numbers and availability.

The information contained in this document is subject to change without notice.

HOW CAN I TELL IF A WALL-HUNG URINAL IS COMPATIBLE?

With Geberit in-wall system 111.625

1 Check water consumption.

Siphonic style urinals must flush with 0.125 GPF (0.5 LPF) or 0.5 GPF (2 LPF) or less. If you do not know your water consumption, go to Step 4.

KNOW YOUR WATER CONSUMPTION? GO TO STEP 2.

2 Check physical features of urinal for compatibility with the Geberit in-wall urinal system.

- a) Urinals do not have integral traps or flushometers
 - b) Urinals are not mounted with wall hangers
 - c) Urinal water supply does not enter through top
- If urinal features are compatible, go to Step 3.

a) Urinals do not have integral traps or flushometers

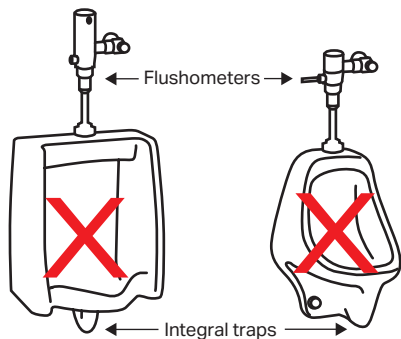

b) Urinals are not mounted with wall hangers

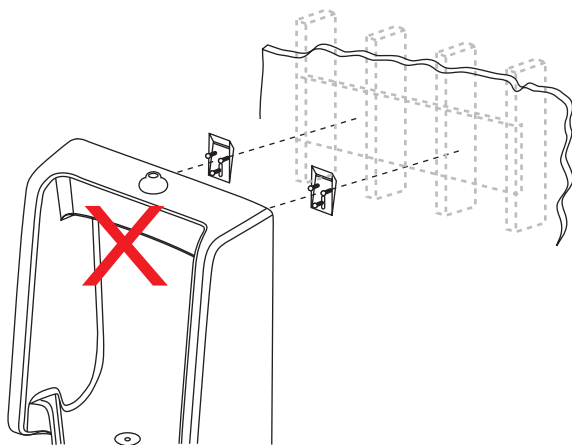

c) Urinal water supply does not enter through top.

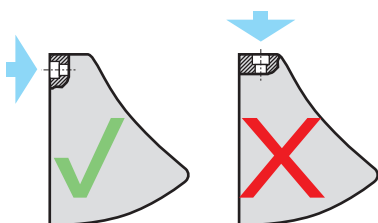

3 Check dimensions.

Check the following hole locations and verify they fall within the dimensions in the drawing below.

- a) Mounting dimensions
- b) Water supply inlet dimensions
- c) Waste outlet dimensions
- d) Must accept accessory plastic trap dimensions indicated below

IF YOU END HERE WITHOUT A MATCH, GO TO STEP 5.

a) Mounting dimensions

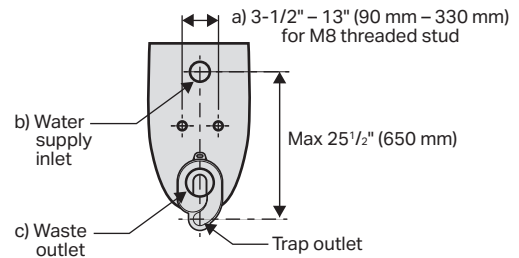

b) Water supply inlet dimensions

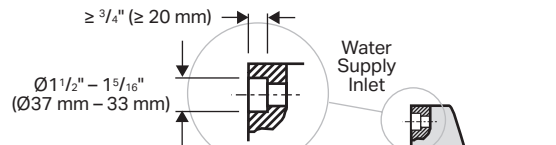

c) Waste outlet dimensions

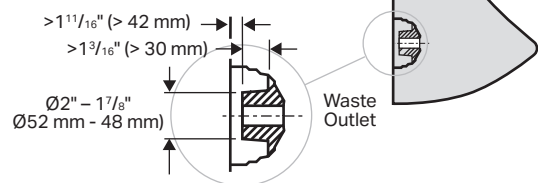

d) Accessory trap dimensions

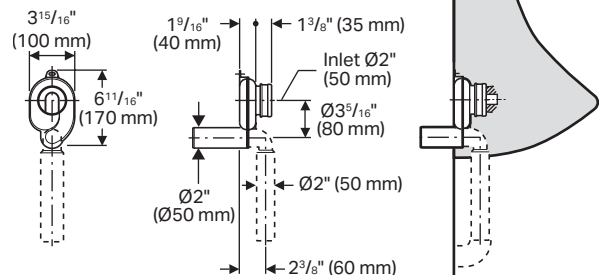

4 Contact us.

800/TEC-TRUE
techsupport.us@geberit.com

Geberit

2100 S. Clearwater Drive
Des Plaines, IL 60018
USA

P 800-566-2100

F 847-803-5454

www.geberit.us

Geberit North America is part of the Geberit Group, a European market leader and global provider of sanitary technology. Located in Des Plaines, Illinois, Geberit North America provides concealed tank and carrier systems for wall-hung and floor-mounted toilets and fixtures. Geberit systems improve the look of any bathroom by hiding the unsightly toilet tank. Replacing a standard tank and toilet with the Geberit system results in more usable space, improved hygiene and better accessibility. The unique dual-flush valve saves water and is practically maintenance free. Geberit also offers cable-controlled bath waste and overflows in a variety of designer finishes. Critical working parts are outside the waterway, ensuring years of trouble-free operation

For more information, contact your Geberit sales representative, call 800/566-2100 or go to **geberit.us**

